

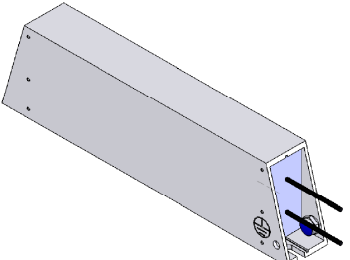

DBR2-300W Aluminium housed braking resistor for Unidrive-M

 WARNING	High temperatures - Risk of Burn Braking resistors can reach high temperatures. Do not mount the resistor on a combustible surface. Locate the braking resistor so that inadvertent contact is not possible. Provide adequate ventilation. Use cable with insulation capable of withstanding high temperatures.	
 WARNING	Thermal Overload protection must be used The thermal switch must be incorporated into the overload protection circuit. The thermal protection circuit must disconnect the AC supply from the drive if the resistor becomes overloaded due to a fault.	

Selection:

The resistance of the braking resistor must be higher than the minimum resistance specified in the drive *User Guide*. The required Pulse Power rating must be calculated to suit the application. Refer to the Drive *User Guide*.

Installation:

The resistor must be mounted as shown in the Table below.
 The resistor housing must be grounded.

The cable between the resistor and the drive must be shielded if the cable is not fully enclosed inside a metal enclosure. The cable does not need to be screened if the braking resistor and drive are both fully enclosed inside the same metal enclosure.

Technical data: DBR2-300W

Part number	1220-0003020	1220-0003050	1220-0003068	1220-0003080	1220-0003100	1220-0003135	1220-0003270
Pulse Power (W) Ta ~ 40 °C Referred to a cycle duration of 120 s. Approximate value (depending on resistance)	ED 6 %	UL 2250 W / CE 2700 W					
	ED 15 %	UL 1250 W / CE 1500 W					
	ED 25 %	UL 750 W / CE 900 W					
	ED 40 %	UL 500 W / CE 600 W					
Nominal continuous power (W) Ta ~40 °C	UL 250 W / CE 300 W						
Resistance values at 20 °C	20 Ω	50 Ω	68 Ω	80 Ω	100 Ω	135 Ω	270 Ω
Tolerance of resistance at 20 °C	±10 %						
Degree of protection (EN 60529)	IP 54						
Maximum permissible operating voltage	UL 600 V / CE 1000 VDC						
Cooling	Natural convection						
Housing temperature at nominal continuous power Ta ~ 40 °C	UL ~ 340 °C / CE ~ 360 °C						
Thermal switch operating temperature	200 °C						
Minimum distance to other equipment	>20 mm						
Electrical connection	2 x AWG 16 / L = 25 cm						
Operating temperature range	-25 ... +40 °C						
Testing voltage	2.7 kV AC (1 s)						
Approvals / marking	UL (File: E226619)						
Mounting positions							



Unidrive-M parameters:

Ramp mode	# 02.004	Fast
Rated power of the resistor	# 10.030	300 W
Thermal time constant	# 10.031	90 s
Resistance value	# 10.061	20 Ω 50 Ω 68 Ω 80 Ω 100 Ω 135 Ω 270 Ω

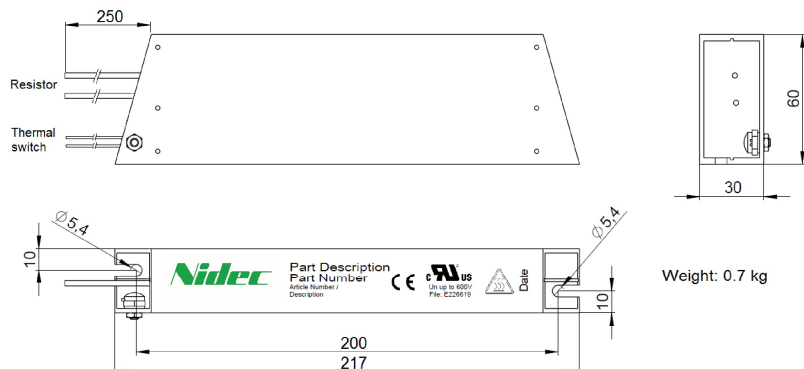
Dimensions:

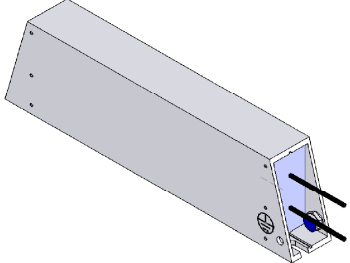

DBR2-500W Aluminium housed braking resistor for Unidrive-M

 WARNING	High temperatures - Risk of Burn Braking resistors can reach high temperatures. Do not mount the resistor on a combustible surface. Locate the braking resistor so that inadvertent contact is not possible. Provide adequate ventilation. Use cable with insulation capable of withstanding high temperatures.	
 WARNING	Thermal Overload protection must be used The thermal switch must be incorporated into the overload protection circuit. The thermal protection circuit must disconnect the AC supply from the drive if the resistor becomes overloaded due to a fault.	

Selection:

The resistance of the braking resistor must be higher than the minimum resistance specified in the drive *User Guide*.
 The required Pulse Power rating must be calculated to suit the application. Refer to the Drive *User Guide*.

Installation:

The resistor must be mounted as shown in the Table below.

The resistor housing must be grounded.

The cable between the resistor and the drive must be shielded if the cable is not fully enclosed inside a metal enclosure. The cable does not need to be screened if the braking resistor and drive are both fully enclosed inside the same metal enclosure.

Technical data: DBR2-500W

Part number	1220-0005020	1220-0005050	1220-0005068	1220-0005080	1220-0005100	1220-0005270
Pulse Power (W) Ta ~ 40 °C Referred to a cycle duration of 120 s. Approximate value (depending on resistance)	ED 6 %	UL 3600 W / CE 4500 W				
	ED 15 %	UL 2000 W / CE 2500 W				
	ED 25 %	UL 1200 W / CE 1500 W				
	ED 40 %	UL 800 W / CE 1000 W				
Nominal continuous power (W) Ta ~ 40 °C	UL 400 W / CE 500 W					
Resistance values at 20 °C	20 Ω	50 Ω	68 Ω	80 Ω	100 Ω	270 Ω
Tolerance of resistance at 20 °C	±10 %					
Degree of protection (EN 60529)	IP 54					
Maximum permissible operating voltage	UL 600 V / CE 1000 VDC					
Cooling	Natural convection					
Housing temperature at nominal continuous power Ta ~ 40 °C	UL ~ 340 °C / CE ~ 360 °C					
Thermal switch operating temperature	200 °C					
Minimum distance to other equipment	>20 mm					
Electrical connection	2 x AWG 16 / L = 25 cm					
Operating temperature range	-25 ... +40 °C					
Testing voltage	2.7 kV AC (1 s)					
Approvals / marking	UL (File: E226619)					
Mounting positions						

Unidrive-M parameters

Ramp mode	# 02.004	Fast
Rated power of the resistor	# 10.030	500 W
Thermal time constant	# 10.031	90 s
Resistance value	# 10.061	20 Ω 50 Ω 68 Ω 80 Ω 100 Ω 270 Ω

Dimensions:

